

clean simplicity



Product range

Contents

Commitment to Clean Simplicity	1
MAIN STATIONS	3-14
MS 0112	7
MS 0127	8
MS 0227	9
MS 0327	10
MS 0427	11
MS 0627	12
MS 0927	13
SATELLITES	15-22
SU NEXT 0127/150	19
SU Baseline 0127/150	20
SU Light 0127/150	21
Trolley	22
NEXT MOBILE UNITS	23-30
MO 0127/0127 XA	27
MO 0227/0227 XA	28
MO 0145/0145 XA	29
AUTOMATIC MAIN STATIONS & SATELLITES	31-34
AMS 300	33
ASU 450	34
BOOSTERS	35-58
27 bar series (B 050-27 → B 1080-27)	40-50
40 bar series (B 090-40 → B 810-40)	52-57
Pre-pressure series (B 120-5F → B 1080-3F)	60-64
PRE-DILUTED SYSTEMS	59-74
PSU 0127 models	69-71
Mixing Stations (B-D 40-10F → B-D 240-10F)	74

RETAIL / INSTITUTIONAL CLEANING EQUIPMENT	76-82
MS & MSC 0106	77-78
SU 0110 TWP Light	79
SU 0110 TWP Light XA	80
SU 0110 TWP Baseline	81
SU 0110 TWP Baseline XA	82
ACCESSORIES	83-91
Hoses	84
Fittings & Can holders	85
Foam & low-pressure guns	86
Chemical hoses & Hose reels	87
Rinsing & Foam nozzles	88
Couplings & Ball valves	89
Rinsing & Foam lances	90
Installation kits	91

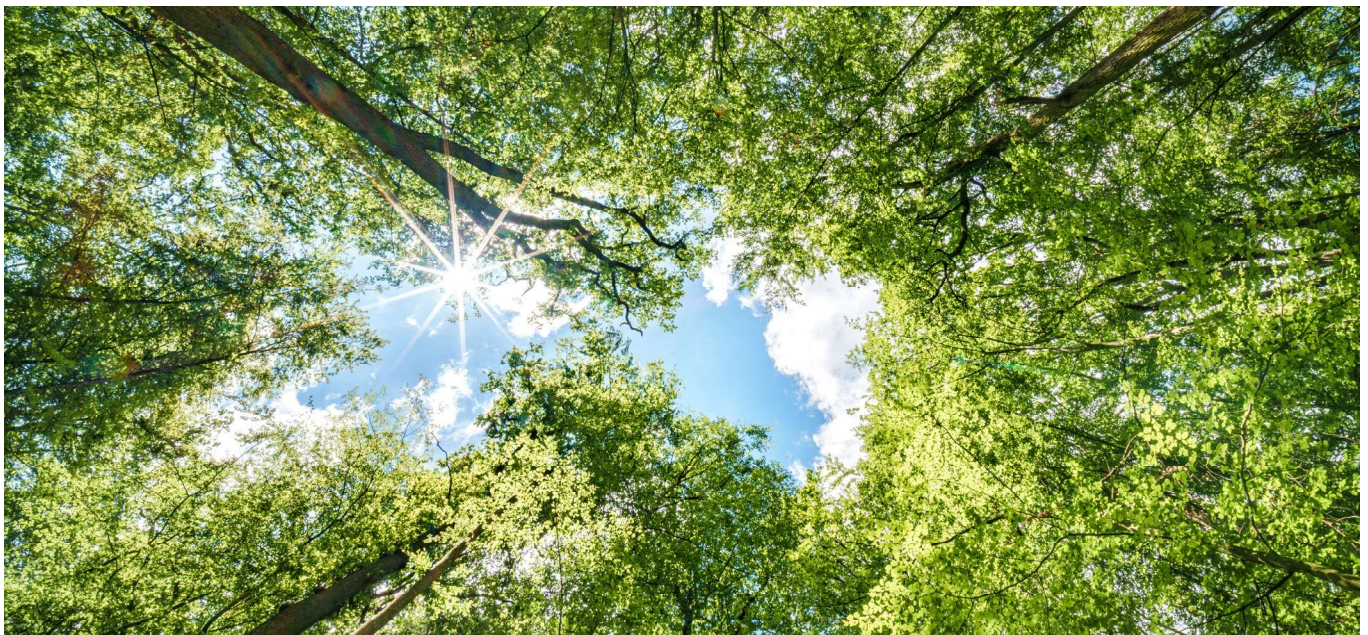

Foamico's commitment to clean simplicity

We are Foamico, your reliable partner in easy cleaning. Our mission is to make cleaning effortless for our customers and end-users through durable products, exceptional user experience, and comprehensive service before and after purchase. Established in 2009, we have grown into a global presence, providing top-quality low-pressure cleaning equipment for the food and beverage industry across five continents. Our extensive network includes cleaning companies, chemical enterprises, and other hygiene-focused businesses.

At Foamico, we prioritize simplicity. We understand that complex processes can hinder efficiency and sustainability. Our approach is grounded in creating straightforward, transparent solutions that make cleaning routines easier and more accessible. We strive to simplify the lives of food and beverage companies by revolutionizing their cleaning processes with innovative, tailored solutions.

Our equipment is renowned for its superior quality, performance, durability, and ease of use. Designed to minimize downtime and resource consumption, our products ensure that cleaning is quick, efficient, and error-free. This not only benefits your bottom line but also boosts your employees' confidence, knowing they are using reliable and effective tools.

Embrace Clean Simplicity with Foamico. As your easy cleaning partner, we deliver Clean Simplicity at its finest.

Explore our website at www.foamico.com or contact us to learn more about how our solutions can make cleaning easier for you.



Main Stations

Main Stations by Foamico is a wall-mounted cleaning system. Equipped with Grundfos pump technology and the Foamico Smart Handle, designed for ease of use by all operators, providing effortless rinsing, foaming and disinfection with minimal effort. Using ordinary tap water (up to 70 °C), the system delivers consistent performance in demanding environments.

With the ability to connect Satellite Units, the system grows with your needs, allowing up to nine users to clean simultaneously and independently. Whether used solo or as a pressurized water source for Foamico Satellite units, Main Stations maximize efficiency in industrial cleaning. The MS Next series features an injector system that supports three chemicals, which can be individually configured as either foam or disinfectant.

Explanation of Model Name

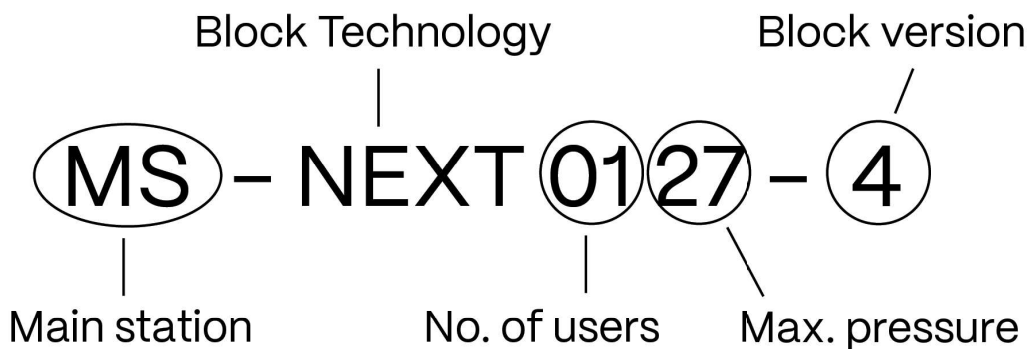

Model	Users	Pressure	Flow rate	Item number	Page
MS NEXT 0112	1	12 bar	50 l/min	7001514	7
MS NEXT 0127-4	1	27 bar	50 l/min	7011518	8
MS NEXT 0227-4	2	27 bar	60 l/min	7011523	9
MS NEXT 0327-4	3	27 bar	100 l/min	7011528	10
MS NEXT 0427-4	4	27 bar	120 l/min	7011533	11
MS NEXT 0627-4	6	27 bar	200 l/min	7011538	12
MS NEXT 0927-4	9	27 bar	270 l/min	7011542	13



Included

All our Mainstations are equipped with a variety of integrated features designed to enhance efficiency and ease of use.



Frequency controlled

with newest Grundfos technology

EI5

High performance with EI5 standard motor



Digital display

Easily readable and integrated into the pump, enhancing user interaction by allowing precise monitoring and control of the pump's settings and performance. Password-protected..



Three-in-One Chemical Block

Single-handle operation streamlines control of all functionalities, enhancing usability and reducing complexity.

Dynamic outlet pressure!

Automatically adjusts up to 27 Bar based on inlet pressure, ensuring optimal performance and efficiency across various applications



Optional

All our Main Stations offer a variety of optional accessories designed to further enhance functionality and customization based on your needs.

EcoClean



Deactivated



Activated

EcoClean allows you with the push of a button to reduce water pressure during rinsing, cutting energy use.

Item Number: 7800465

AirVent



Automatic AirVent for extra protection of the pump.

Item Number: 7800418

FlowGuard

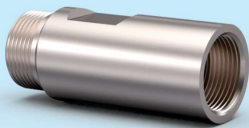

Our FlowGuard is a patented technology designed to enhance performance and reduced water usage.

Item Number: 1002509

Additional accessories



To enhance the functionality and customization of our products, we offer a range of additional accessories. You can find the full selection at the back of the catalog.

MS 0112

Included accessories

- 3x Chemical Limiting Nozzle set
- 25/30 Rinsing Nozzle – "High Impact"
- 25/30 Rinsing Lance – "High Impact"
- 50/200 Foam Nozzle
- 40/30 Disinfection Nozzle
- Nozzle holder

Optional accessories

- Automatic air vent
- EcoClean
- FlowGuard



Technical Specifications	Unit	MS NEXT 0112
Pump pressure at 2 bar inlet pressure	Bar/PSI	12/174
Max. Water consumption	L/Min	50
Pipe dimension inlet/outlet	Inch	1"
Standard Voltage	V	1x220x240
Frequency & Power	Hz/kW	50-60/1,1
Dimensions (WxHxD)	mm	502x677x370
Weight	Kg	78
Users (simultaneous)	Amount	1
Item Number	No.	7001514

* Possible to add compressor



MS 0127

Included accessories

- 3x Chemical Limiting Nozzle set
- 25/30 Rinsing Nozzle – "High Impact"
- 25/30 Rinsing Lance – "High Impact"
- 50/200 Foam Nozzle
- 40/30 Disinfection Nozzle
- Nozzle holder

Optional accessories

- Automatic air vent
- EcoClean
- FlowGuard



Technical Specifications	Unit	MS NEXT 0127
Pump pressure at 7 bar inlet pressure	Bar/PSI	27/392
Max. Water consumption	L/Min	50
Pipe dimension inlet/outlet	Inch	1 ¼"
Standard Voltage	V	380–500
Frequency & Power	Hz/kW	50–60/2,2
Dimensions (WxHxD)	mm	502x952x371
Weight	Kg	55
Users (simultaneous)	Amount	1
Item Number	No.	7001518

MS 0227

Included accessories

- 3x Chemical Limiting Nozzle set
- 25/30 Rinsing Nozzle – "High Impact"
- 25/30 Rinsing Lance – "High Impact"
- 50/200 Foam Nozzle
- 40/30 Disinfection Nozzle
- Nozzle holder

Optional accessories

- Automatic air vent
- EcoClean
- FlowGuard



Technical Specifications	Unit	MS NEXT 0227
Pump pressure at 7 bar inlet pressure	Bar/PSI	27/392
Max. Water consumption	L/Min	60
Pipe dimension inlet/outlet	Inch	1 ¼"
Standard Voltage	V	380–500
Frequency & Power	Hz/kW	50–60/3,0
Dimensions (WxHxD)	mm	502x952x371
Weight	Kg	74
Users (simultaneous)	Amount	2
Item Number	No.	7001523



MS 0327

Included accessories

- 3x Chemical Limiting Nozzle set
- 25/30 Rinsing Nozzle – "High Impact"
- 25/30 Rinsing Lance – "High Impact"
- 50/200 Foam Nozzle
- 40/30 Disinfection Nozzle
- Nozzle holder

Optional accessories

- Automatic air vent
- EcoClean
- FlowGuard



Technical Specifications	Unit	MS NEXT 0327
Pump pressure at 7 bar inlet pressure	Bar/PSI	27/392
Max. Water consumption	L/Min	100
Pipe dimension inlet/outlet	Inch	1 ¼"
Standard Voltage	V	380-500
Frequency & Power	Hz/kW	50-60/4,0
Dimensions (WxHxD)	mm	502x952x371
Weight	Kg	79
Users (simultaneous)	Amount	3
Item Number	No.	7011528

MS 0427

- Included accessories
- 3x Chemical Limiting Nozzle set
- 25/30 Rinsing Nozzle – "High Impact"
- 25/30 Rinsing Lance – "High Impact"
- 50/200 Foam Nozzle
- 40/30 Disinfection Nozzle
- Nozzle holder

- Optional accessories
- Automatic air vent
 - EcoClean
 - FlowGuard



Technical Specifications	Unit	MS NEXT 0427
Pump pressure at 7 bar inlet pressure	Bar/PSI	27/392
Max. Water consumption	L/Min	120
Pipe dimension inlet/outlet	Inch	1 ¼"
Standard Voltage	V	380–500
Frequency & Power	Hz/kW	50–60/6,0
Dimensions (WxHxD)	mm	502x952x371
Weight	Kg	82
Users (simultaneous)	Amount	4
Item Number	No.	7011533



MS 0627

- Included accessories
- 3x Chemical Limiting Nozzle set
- 25/30 Rinsing Nozzle – "High Impact"
- 25/30 Rinsing Lance – "High Impact"
- 50/200 Foam Nozzle
- 40/30 Disinfection Nozzle
- Nozzle holder

Optional accessories

- Automatic air vent
- EcoClean
- FlowGuard



Technical Specifications	Unit	MS NEXT 0627
Pump pressure at 7 bar inlet pressure	Bar/PSI	27/392
Max. Water consumption	L/Min	120
Pipe dimension inlet/outlet	Inch	1 ½"
Standard Voltage	V	380–500
Frequency & Power	Hz/kW	50–60/7,5
Dimensions (WxHxD)	mm	632x1167x460
Weight	Kg	124
Users (simultaneous)	Amount	6
Item Number	No.	7011538

MS 0927

Included accessories

- 3x Chemical Limiting Nozzle set
- 25/30 Rinsing Nozzle – "High Impact"
- 25/30 Rinsing Lance – "High Impact"
- 50/200 Foam Nozzle
- 40/30 Disinfection Nozzle
- Nozzle holder

Optional accessories

- Automatic AirVent
- EcoClean
- FlowGuard



Technical Specifications	Unit	MS NEXT 0927
Pump pressure at 7 bar inlet pressure	Bar/PSI	27/392
Max. Water consumption	L/Min	270
Pipe dimension inlet/outlet	Inch	2"
Standard Voltage	V	380–500
Frequency & Power	Hz/kW	50–60/11,0
Dimensions (WxHxD)	mm	632x1167x460
Weight	Kg	124
Users (simultaneous)	Amount	9
Item Number	No.	7011542







Satellites

Foamico satellite units provide efficient, durable, and user-friendly cleaning solutions tailored to industrial needs. Satellite units connect to a Foamico Main Station or booster for pressurized water up to 70 °C, functioning as independent cleaning units. Designed for performance and easy maintenance, our satellites come in various configurations to suit different cleaning requirements.

Our three main models are the Next-, Baseline- and Light Satellite.

The Next can handle up to three chemicals. The Baseline handles two chemicals and the Light is ideal for one chemical. The Foamico Smart Handle is featured on the Next and Baseline Satellites.

Explanation of Model Name

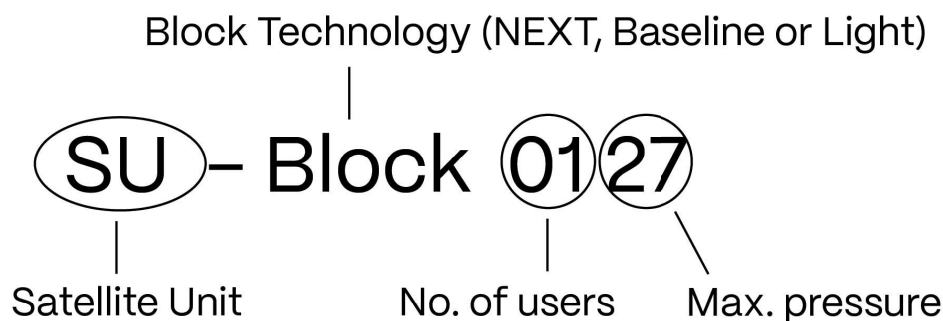

Model	Users	Pressure	Flow rate	Item number	Page
SU Next 0127/0150	1	27/50 bar	100 l/min	7011504/09	19
SU Baseline 0127/0150	1	27/50 bar	50 l/min	7011330/33	20
SU Light 0127/0150	1	27/50 bar	50 l/min	7011021/22	21
Trolley	-	-	-	7002085	22

Included

All our Satelites are equipped with a variety of integrated features designed to enhance efficiency and ease of use.



Smart Switch

Single-handle operation streamlines control of all functionalities.

Dedicated injectors

One injector per chemical (up to 3) prevents crystallization and reduces maintenance.

Optional

All our Satelites offer a variety of optional accessories designed to further enhance functionality and customization based on your needs.

FlowGuard

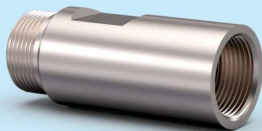

Our FlowGuard is a patented technology designed to enhance performance and reduced water usage.

Item Number: 1002509

Installationkits

Size	Item number
Water	7800395 ½"
Air	7800449 ½"

Additional accessories



To enhance the functionality and customization of our products, we offer a range of additional accessories. You can find the full selection at the back of the catalog



SU NEXT 0127/0150

Included accessories

- 3x Chemical Limiting Nozzle set
- 25/30 Rinsing Nozzle - "High Impact"
- 25/30 Rinsing Lance - "High Impact"
- 50/200 Foam Nozzle
- 40/30 Disinfection Nozzle
- Nozzle holder

→ Optional accessories

- Foamico hose
- Low pressure valve/low pressure gun
- Hose holder or hose reels
- Trolley



Technical Specifications	Unit	NEXT 0127	NEXT 0150
Min./Max. Inlet pressure	Bar/PSI	10-27/145-392	25-50/363-725
Max. water consumption	L/Min	100	100
Pipe dimesions inlet (Water)	Inch	½"	½"
Pipe dimesions inlet (Air)	mm	8	8
Air supply	Bar/PSI	5-10/73-145	5-10/73-145
Air consumption	L/Min	150-200	150-200
Dimensions (WxHxD)	mm	295x216x228	295x216x228
Weight	Kg	7	7
Item Number	No.	7011504	7011509



SU Baseline 0127/0150

Included accessories

- 2x Chemical Limiting Nozzle set
- 25/30 Rinsing Nozzle - "High Impact"
- 50/200 Foam Nozzle
- 40/30 Sanitizer Nozzle

→ Optional accessories

- Foamico hose
- Low pressure valve/low pressure gun
- Hose holder or hose reels
- Trolley

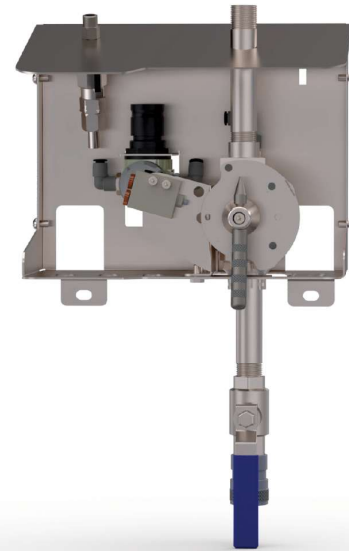

Technical Specifications	Unit	Baseline 0127	Baseline 0150
Min./Max. Inlet pressure	Bar/PSI	10-27/145-392	25-50/363-725
Max. water consumption	L/Min	50	50
Pipe dimensions inlet (Water)	Inch	1/2"	1/2"
Pipe dimensions inlet (Air)	mm	8	8
Air supply	Bar/PSI	5-10/73-145	5-10/73-145
Air consumption	L/Min	150-200	150-200
Dimensions (WxHxD)	mm	260x210x210	260x210x210
Weight	Kg	7	7
Item Number	No.	7011330	7011333

SU Light 0127/0150

Included accessories

- Chemical Limiting Nozzle set
- 25/30 Rinsing Nozzle - "High Impact"
- 50/200 Foam Nozzle
- Nozzle holder

→ Optional accessories

- Foamico hose
- Low pressure valve/low pressure gun
- Hose holder or hose reels
- Trolley

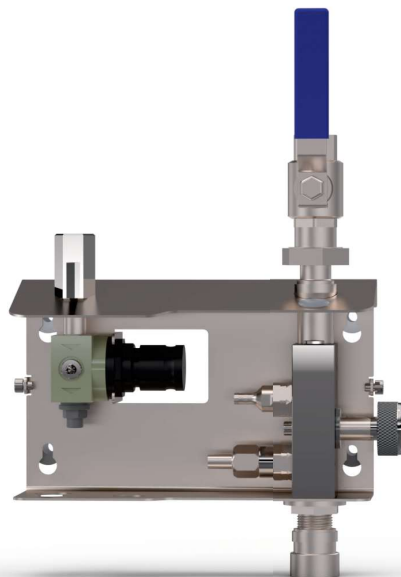

Technical Specifications	Unit	Light 0127	Light 0150
Min./Max. Inlet pressure	Bar/PSI	10-27/145-392	25-50/363-725
Max. water consumption	L/Min	50	50
Pipe dimesions inlet (Water)	Inch	1/2"	1/2"
Pipe dimesions inlet (Air)	mm	8	8
Air supply	Bar/PSI	5-10/73-145	5-10/73-145
Air consumption	L/Min	150-200	150-200
Dimensions (WxHxD)	mm	220x330x80	220x330x80
Weight	Kg	3,5	3,5
Item Number	No.	7011021	7011022



Trolley

- Optional accessories
- Foamico inlet hose



Technical Specifications	Unit	Trolley
Min./Max. Inlet pressure	Bar/PSI	-
Max. water consumption	L/Min	-
Pipe dimesions inlet (Water)	Inch	-
Pipe dimesions inlet (Air)	mm	-
Air supply	Bar/PSI	-
Air consumption	L/Min	-
Dimensions (WxHxD)	mm	705x1074x827
Weight	Kg	22
Item Number	No.	7002085

NEXT Mobile units

Foamico mobile units are designed for standalone use, available in 27 and 45 bar models. The 45-bar model offers flexibility by operating at both pressures. Units are available with or without a compressor to suit different needs.

Built for easy handling, the unit features a sturdy, fully stainless-steel enclosure and is easy to maintain, ensuring minimal downtime. It is equipped with a Grundfos pump that delivers high energy efficiency and operates with water up to 70 °C. To simplify cleaning and protect the pump, customers should purchase an AirVent to avoid manual venting before each use.

Explanation of Model Name

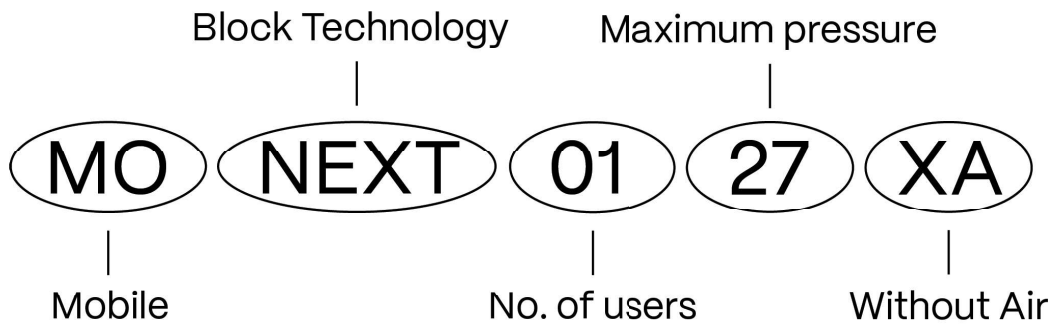

Model	Users	Pressure	Flow rate	Item number	Page
Mobile 0127/0127 XA	1	27 bar	60 l/min	7011548/54	27
Mobile 0227 & 0227 XA	2	27 bar	50 l/min	7011559/64	28
Mobile 0145 & 0145 XA	1	45 bar	50 l/min	7011613/18	29



Included

All our Mobile units are equipped with a variety of integrated features designed to enhance efficiency and ease of use.



Frequency controlled

with newest Grundfos technology

EI5

High performance with EI5 standard motor



Digital display

Easily readable and integrated into the pump, enhancing user interaction by allowing precise monitoring and control of the pump's settings and performance. Password-protected.



Three-in-One Chemical Block

Single-handle operation streamlines control of all functionalities, enhancing usability and reducing complexity.

Dynamic outlet pressure!

Automatically adjusts up to 27 Bar based on inlet pressure, ensuring optimal performance and efficiency across various applications.



Optional

All our Mobile unit offer a variety of optional accessories designed to further enhance functionality and customization based on your needs.

EcoClean

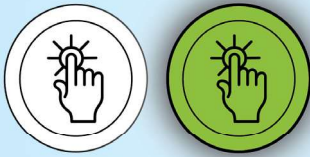

Deactivated Activated

EcoClean allows you with the push of a button to reduce water pressure during rinsing, cutting energy use.

Item Number: 7800465

AirVent



Automatic AirVent for extra protection of the pump.

Item Number: 7800418

FlowGuard

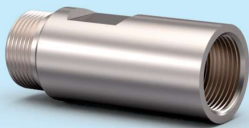

Our FlowGuard is a patented technology designed to enhance performance and reduced water usage.

Item Number: 1002509



Additional accessories

To enhance the functionality and customization of our products, we offer a range of additional accessories. You can find the full selection at the back of the catalog.

MO 0127/0127 XA

Included accessories

- 3x Chemical Limiting Nozzle set
- 25/30 Rinsing Nozzle – "High Impact"
- 25/30 Rinsing Lance – "High Impact"
- 50/200 Foam Nozzle
- 40/30 Disinfection Nozzle
- Nozzle holder

Optional accessories

- AirVent
- EcoClean
- FlowGuard
- Inlet/outlet hose



Technical Specifications	Unit	MO 0127	MO 0127 XA
Pump pressure at 7 bar inlet pressure	Bar/PSI	27/392	27/392
Max. water consumption	L/Min	60	60
Pipe dimension inlet/outlet	Inch	3/4" / 1/2"	3/4" / 1/2"
Standard Voltage	V	380-500	380-500
Frequency & Power	Hz/kW	50-60/2,2+1,0	50-60/2,2
Dimensions (WxHxD)	mm	725x975x985	725x975x985
Weight	Kg	114	99
Users (simultaneous)	Amount	1	1
Item Number	No.	7011548	7011554



MO 0227/0227 XA

- Included accessories
- 3x Chemical Limiting Nozzle set
- 25/30 Rinsing Nozzle – "High Impact"
- 25/30 Rinsing Lance – "High Impact"
- 50/200 Foam Nozzle
- 40/30 Disinfection Nozzle
- Nozzle holder

Optional accessories

- AirVent
- EcoClean
- FlowGuard
- Inlet/outlet hose



Technical Specifications	Unit	MO 0227	MO 0227 XA
Pump pressure at 7 bar inlet pressure	Bar/PSI	27/392	27/392
Max. water consumption	L/Min	100	100
Pipe dimension inlet/outlet	Inch	1"/ 1/2"	1"/ 1/2"
Standard Voltage	V	380–500	380–500
Frequency & Power	Hz/kW	50–60/4,0+1,0	50–60/4,0
Dimensions (WxHxD)	mm	725x975x985	725x975x985
Weight	Kg	126	99
Users (simultaneous)	Amount	2	2
Item Number	No.	7011559	7011564

MO 0145/0145 XA

- Included accessories
- 3x Chemical Limiting Nozzle set
- 25/30 Rinsing Nozzle – "High Impact"
- 25/30 Rinsing Lance – "High Impact"
- 50/200 Foam Nozzle
- 40/30 Disinfection Nozzle
- Nozzle holder

Optional accessories

- EcoClean
- FlowGuard
- Inlet/outlet hose



Technical Specifications	Unit	MO 0145	MO 0145 XA
Pump pressure at 7 bar inlet pressure	Bar/PSI	27/392	27/392
Max. water consumption	L/Min	60	60
Pipe dimension inlet/outlet	Inch	3/4" / 1/2"	3/4" / 1/2"
Standard Voltage	V	380-500	380-500
Frequency & Power	Hz/kW	50-60/6,0+1,0	50-60/6,0
Dimensions (WxHxD)	mm	725x1225x985	725x1225x985
Weight	Kg	150	135
Users (simultaneous)	Amount	1	1
Item Number	No.	7011613	7011618



Automatic systems

Foamico’s automatic cleaning system, powered by our Next technology, offers high flexibility. It controls up to 16 external valves, enabling the cleaning of multiple production zones individually or simultaneously.

Designed for cleaning food processing equipment like conveyors, fillers, and tanks, it ensures thorough cleaning while drastically reducing water, energy, and labor costs.

Available as a Main Station with a Grundfos pump or as a Satellite Station without, the system can use up to three chemicals through a single outlet. The onboard automatic controller can be accessed and programmed via the built-in HMI or remotely through WiFi from a smartphone, tablet, or PC. Additionally, admin and user access can be configured to provide different levels of control.

Explanation of Model Name

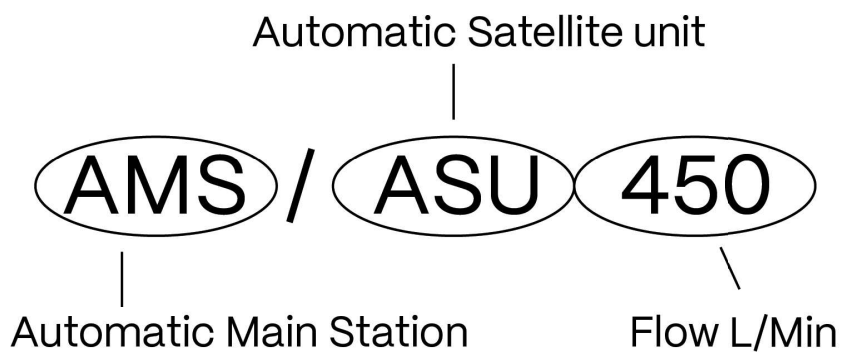

Model	Zones	Pressure	Flow rate	Item number	Page
AMS (150/300/450)	16	16 bar	300 l/min	7011800/01/02	33
ASU (150/300/450)	16	10–30 bar	450 l/min	7011810/11/12	34



What makes our Automatic systems unique?

All our Automatic systems are equipped with a variety of features designed to enhance efficiency and ease of use.



Easy Setup

Easy Setup makes the systems quick to install and simple to use.

Manager and cleaner access

Manager and Cleaner Access lets managers control settings while cleaners use only the needed functions.

Manual Next Outlet



Single-handle operation streamlines control of all functionalities, enhancing usability and reducing complexity.

* This feature is optional
Item number: 1700403

One outlet

By combining our Next block with a motorized valve, we create the flexibility of a single outlet solution.

Preprogrammed

Our automation systems can be delivered with pre-programmed cleaning programs such as rinse-foam-rinse or rinse-foam-disinfection.

AMS

Included

- Foam Injector sizes: 150l/min, 300l/min & 450l/min
- Possibility of 10 programs

Optional

- AirVent



Technical Specifications	Unit	AMS 450
Pump pressure (2 bar inlet)	Bar/PSI	16
Max. Water consumption	L/Min	300
Pipe dimension inlet/outlet	Inch	2"
Standard Voltage	V	380-500
Frequency & Power	Hz/kW	50-60/6,0
Dimensions (WxHxD)	mm	825x1200x475
Weight	Kg	146
Controlable zones	Amount	16
Item Number	No.	7011800/01/02



ASU

- Included
- Foam Injector sizes: 150l/min, 300l/min & 450l/min
- Possibility of 10 programs



Technical Specifications	Unit	ASU 450
Min./Max. Inlet pressure	Bar/PSI	2-30/ 29-435
Max. Water consumption	L/Min	450
Pipe dimension inlet/outlet	Inch	1 ¼"
Standard Voltage	V	220/380-500
Frequency	Hz	50-60
Dimensions (WxHxD)	mm	502x951x402
Weight	Kg	47
Controlable zones	Amount	16
Item Number	No.	7011810/11/12





Boosters

Foamico believes that efficient cleaning starts with a reliable water supply. Our booster solutions are designed to transform ordinary tap water into a powerful cleaning resource – ensuring the right pressure, the right flow, and the right performance every time.

All Foamico boosters are equipped with a PT1000 temperature sensor, safeguarding system performance.

Whether you need stable 27 bar supply, the extra power of 40 bar, or inlet support with a pre-booster, the Foamico booster program gives you the flexibility to build a solution tailored to your facility. Robust, efficient, and easy to integrate, our boosters are the foundation of Cleaning Simplicity – securing maximum hygiene with minimum effort.



Model	Users	Pressure	Flow rate	Page
27 bar boosters	1-36	27 bar	50-1080 l/min	39-50
40 bar boosters	1-36	40 bar	60-1080 l/min	51-57
Pre-pressure boosters	-	3/5 bar	120-1080 l/min	59-64



Included

All our Boosters are equipped with a variety of integrated features designed to enhance efficiency and ease of use.



Frequency controlled

High performance with newest Grundfos EI5 standard motor

EI5

High performance with EI5 standard motor



Digital display

Easily readable and integrated into the pump, enhancing user interaction by allowing precise monitoring and control of the pump's settings and performance. Password-protected..

AirVent



Automatic air vent. Valve for extra protection of the pump.
Item Number: 7800418

* Optional

Dynamic outlet pressure!

Automatically adjusts up to 27 Bar based on inlet pressure, ensuring optimal performance and efficiency across various applications.

Installation kits

Size	Item number
1 ¼"	7800399
1 ½"	7800400
2"	7800401

* Optional

27 Bar Boosters

Foamico boosters are designed for central installation, ensuring a reliable pressurized water supply for Foamico satellites. Our booster program allows you to tailor a solution to your specific cleaning needs, selecting the ideal booster based on the total water consumption required for multiple satellites operating simultaneously.

Foamico's 27 bar booster series increases water pressure from Tapwater pressure up to 27 bars while delivering up to 1080 liters per minute.

Explanation of Model Name

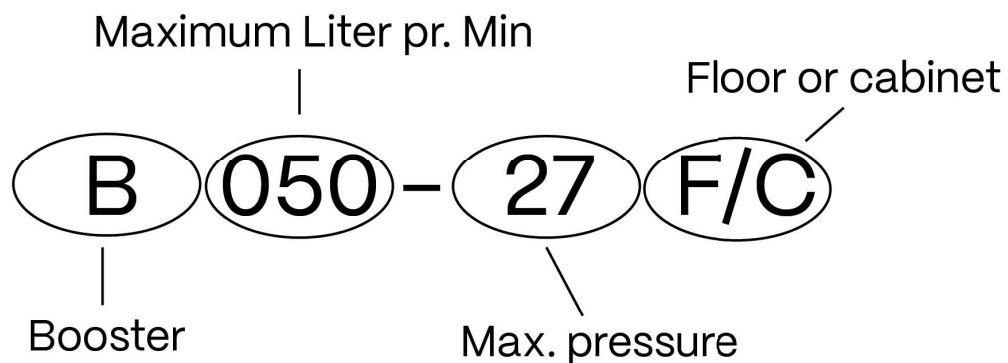

Model	Users	Pressure	Flow rate	Item number	Page
B 050-27 F/C	1	27 bar	50	7012000/01	40
B 065-27 F/C	2	27 bar	65	7012002/03	41
B 100-27 F/C	3	27 bar	100	7012004/05	42
B 120-27 F/C	4	27 bar	120	7012006/07	43
B 200-27 F/C	6	27 bar	200	7012008/09	44
B 270-27 F/C	9	27 bar	270	7012010/11	45
B 400-27 F	12	27 bar	400	7012021	46
B 540-27 F	18	27 bar	540	7012022	47
B 630-27 F	21	27 bar	630	7012023	48
B 810-27 F	27	27 bar	810	7012024	49
B 1080-27 F	36	27 bar	1080	7012025	50



B 050-27



Optional accessories

→ AirVent

→ Installation kits

Technical Specifications	Unit	B 050-27 F	B 050-27 C
Pump pressure (7 bar inlet)	Bar	27	27
Max. water consumption	L/Min	50	50
Pipe dimesions inlet/outlet	Inch	1¼"	1¼"
Standard Voltage	V	380-500	380-500
Frequency & Power	Hz/kW	50-60/2,2	50-60/2,2
Dimensions (WxHxD)	mm	423x1038x400	502x952x367
Weight	Kg	57	74
Users (simultaneous)	Amount	1	1
Item Number	No.	7012000	7012001

B 065-27



Optional accessories

→ AirVent

→ Installation kits

Technical Specifications	Unit	B 065-27 F	B 065-27 C
Pump pressure (7 bar inlet)	Bar	27	27
Max. water consumption	L/Min	65	65
Pipe dimensions inlet/outlet	Inch	1 ¼"	1 ¼"
Standard Voltage	V	380-500	380-500
Frequency & Power	Hz/kW	50-60/3,0	50-60/3,0
Dimensions (WxHxD)	mm	423x1038x400	502x952x367
Weight	Kg	60	77
Users (simultaneous)	Amount	2	2
Item Number	No.	7012002	7012003



B 100-27



Optional accessories

→ AirVent

→ Installation kits

Technical Specifications	Unit	B 100-27 F	B 100-27 C
Pump pressure (7 bar inlet)	Bar	27	27
Max. water consumption	L/Min	100	100
Pipe dimensions inlet/outlet	Inch	1 ¼"	1 ¼"
Standard Voltage	V	380-500	380-500
Frequency & Power	Hz/kW	50-60/4,0	50-60/4,0
Dimensions (WxHxD)	mm	423x1038x400	502x952x367
Weight	Kg	57	74
Users (simultaneous)	Amount	3	3
Item Number	No.	7012004	7012005

B 120-27



Optional accessories

→ AirVent

→ Installation kits

Technical Specifications	Unit	B 120-27 F	B 120-27 C
Pump pressure (7 bar inlet)	Bar	27	27
Max. water consumption	L/Min	120	120
Pipe dimensions inlet/outlet	Inch	1 ¼"	1 ¼"
Standard Voltage	V	380-500	380-500
Frequency & Power	Hz/kW	50-60/6.0	50-60/6.0
Dimensions (WxHxD)	mm	423x1038x400	502x952x367
Weight	Kg	60	77
Users (simultaneous)	Amount	4	4
Item Number	No.	7012006	7012007



B 200-27



Optional accessories

→ AirVent

→ Installation kits

Technical Specifications	Unit	B 200-27 F	B 200-27 C
Pump pressure (7 bar inlet)	Bar	27	27
Max. water consumption	L/Min	200	200
Pipe dimensions inlet/outlet	Inch	1½"	1½"
Standard Voltage	V	380-500	380-500
Frequency & Power	Hz/kW	50-60/7,5	50-60/7,5
Dimensions (WxHxD)	mm	535x1070x400	635x1200x470
Weight	Kg	95	122
Users (simultaneous)	Amount	6	6
Item Number	No.	7012008	7012009

B 270-27



Optional accessories

→ AirVent

→ Installation kits

Technical Specifications	Unit	B 270-27 F	B 270-27 C
Pump pressure (7 bar inlet)	Bar	27	27
Max. water consumption	L/Min	270	270
Pipe dimensions inlet/outlet	Inch	2"	2"
Standard Voltage	V	380-500	380-500
Frequency & Power	Hz/kW	50-60/11.0	50-60/11.0
Dimensions (WxHxD)	mm	580x1150x400	632x1171x461
Weight	Kg	110	130
Users (simultaneous)	Amount	9	9
Item Number	No.	7012010	7012011



B 400-27



Optional accessories
 → AirVent

Technical Specifications	Unit	B 400-27
Pump pressure (7 bar inlet)	Bar	27
Max. water consumption	L/Min	400
Pipe dimensions inlet/outlet	Inch/DN	3"/80
Standard Voltage	V	380-500
Frequency & Power	Hz/kW	50-60/2x7,5
Dimensions (WxHxD)	mm	1200x1080x1110
Weight	Kg	240
Users (simultaneous)	Amount	13
Item Number	No.	7012021

B 540-27



Optional accessories
→ AirVent

Technical Specifications	Unit	B 540-27
Pump pressure (7 bar inlet)	Bar	27
Max. water consumption	L/Min	540
Pipe dimensions inlet/outlet	Inch/DN	3"/80
Standard Voltage	V	380-500
Frequency & Power	Hz/kW	50-60/2x11,0
Dimensions (WxHxD)	mm	1200x1080x1110
Weight	Kg	255
Users (simultaneous)	Amount	18
Item Number	No.	7012022



B 630-27



Optional accessories
 → AirVent

Technical Specifications	Unit	B 630-27
Pump pressure (7 bar inlet)	Bar	27
Max. water consumption	L/Min	630
Pipe dimesions inlet/outlet	Inch/DN	3"/80
Standard Voltage	V	380-500
Frequency & Power	Hz/kW	50-60/3x7,5
Dimensions (WxHxD)	mm	1650x1080x1110
Weight	Kg	290
Users (simultaneous)	Amount	21
Item Number	No.	7012023

B 810-27



Optional accessories
 → AirVent

Technical Specifications	Unit	B 810-27
Pump pressure (7 bar inlet)	Bar	27
Max. water consumption	L/Min	810
Pipe dimesions inlet/outlet	Inch/DN	3"/80
Standard Voltage	V	380-500
Frequency & Power	Hz/kW	50-60/3x11.0
Dimensions (WxHxD)	mm	1650x1080x1110
Weight	Kg	330
Users (simultaneous)	Amount	27
Item Number	No.	7012024



B 1080-27



Optional accessories
 → AirVent

Technical Specifications	Unit	B 1080-27
Pump pressure (7 bar inlet)	Bar	27
Max. water consumption	L/Min	1080
Pipe dimesions inlet/outlet	Inch/DN	4"/100
Standard Voltage	V	380-500
Frequency & Power	Hz/kW	50-60/4x11,0
Dimensions (WxHxD)	mm	2100x1100x1200
Weight	Kg	650
Users (simultaneous)	Amount	36
Item Number	No.	7012025

40 Bar Boosters

Foamico boosters are designed for central installation, ensuring a reliable pressurized water supply for Foamico satellites. Our booster program allows you to tailor a solution to your specific cleaning needs, selecting the ideal booster based on the total water consumption required for multiple satellites operating simultaneously.

Foamico's 40 bar booster series increases water pressure from Tapwater pressure up to 40 bars while delivering up to 1080 liters per minute.

Explanation of Model Name

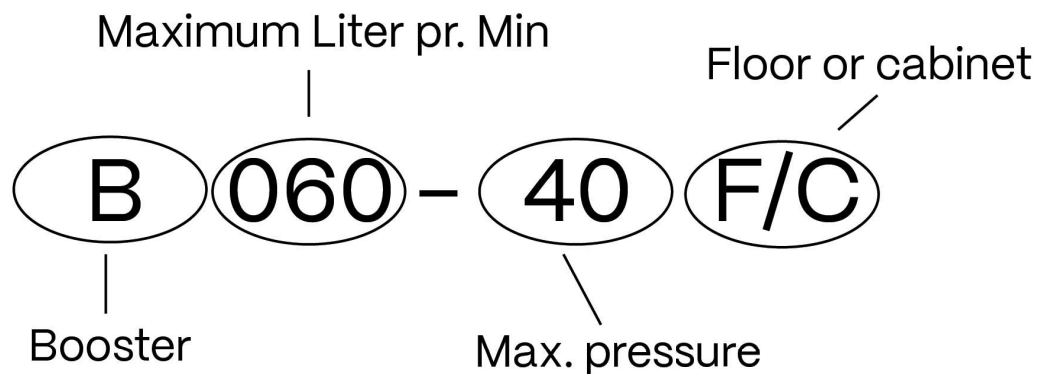

Model	Users	Pressure	Flow rate	Item number	Page
B 090-40 F/C	2	40 bar	90 l/min	7012013/15	52
B 200-40	6	40 bar	200 l/min	7012030	53
B 270-40	9	40 bar	270 l/min	7012031	54
B 400-40	12	40 bar	400 l/min	7012033	55
B 540-40	18	40 bar	540 l/min	7012034	56
B 810-40	27	40 bar	810 l/min	7012035	57



B 090-40



Optional accessories
→ Installation kits

Technical Specifications	Unit	B 090-40 F	B 090-40 C
Pump pressure (7 bar inlet)	Bar	40	40
Max. water consumption	L/Min	90	90
Pipe dimensions inlet/outlet	Inch	1 ¼"	1 ¼"
Standard Voltage	V	380-480	380-480
Frequency & Power	Hz/kW	50-60/6,0	50-60/6,0
Dimensions (WxHxD)	mm	450x110x400	450x110x400
Weight	Kg	62	66
Users (simultaneous)	Amount	2	2
Item Number	No.	7012013	7012015

B 200-40



Optional accessories
→ Installation kits

Technical Specifications	Unit	B 200-40
Pump pressure (7 bar inlet)	Bar	40
Max. water consumption	L/Min	200
Pipe dimensions inlet/outlet	Inch	1½"
Standard Voltage	V	380-480
Frequency & Power	Hz/kW	50-60/2x7,5
Dimensions (WxHxD)	mm	550x1050x1050
Weight	Kg	300
Users (simultaneous)	Amount	6
Item Number	No.	7012030



B 270-40



Optional accessories
→ Installation kits

Technical Specifications	Unit	B 270-40
Pump pressure (7 bar inlet)	Bar	40
Max. water consumption	L/Min	270
Pipe dimensions inlet/outlet	Inch	2"
Standard Voltage	V	380-480
Frequency & Power	Hz/kW	50-60/2x11,0
Dimensions (WxHxD)	mm	600x1100x1150
Weight	Kg	376
Users (simultaneous)	Amount	9
Item Number	No.	7012031

B 400-40



Technical Specifications	Unit	B 400-40
Pump pressure (7 bar inlet)	Bar	40
Max. water consumption	L/Min	400
Pipe dimesions inlet/outlet	Inch/DN	3"/80
Standard Voltage	V	380-480
Frequency & Power	Hz/kW	50-60/4x7,5
Dimensions (WxHxD)	mm	1400x1100x1200
Weight	Kg	550
Users (simultaneous)	Amount	12
Item Number	No.	7012033



B 540-40



Technical Specifications	Unit	B 540-40
Pump pressure (7 bar inlet)	Bar	40
Max. water consumption	L/Min	540
Pipe dimesions inlet/outlet	Inch/DN	3"/80
Standard Voltage	V	380-480
Frequency & Power	Hz/kW	50-60/4x11,0
Dimensions (WxHxD)	mm	1400x1300x1450
Weight	Kg	950
Users (simultaneous)	Amount	18
Item Number	No.	7012034

B 810-40



Technical Specifications

Unit B 810-40

Pump pressure (7 bar inlet)

Bar 40

Max. water consumption

L/Min 810

Pipe dimensions inlet/outlet

Inch/DN 3"/80

Standard Voltage

V 380-480

Frequency & Power

Hz/kW 50-60/6x11,0

Dimensions (WxHxD)

mm 1550x1100x1650

Weight

Kg 900

Users (simultaneous)

Amount 27

Item Number

No. 7012035



Pre-Pressure Boosters

The pre-pressure booster increases the water pressure when the customer's tap water supply is too low or when drawing water from a tank, allowing the main pump to deliver the optimal pressure needed for effective cleaning.

A pre-pressure booster increases the inlet pressure to the main booster, ensuring reliable water flow even under challenging conditions.

Explanation of Model Name

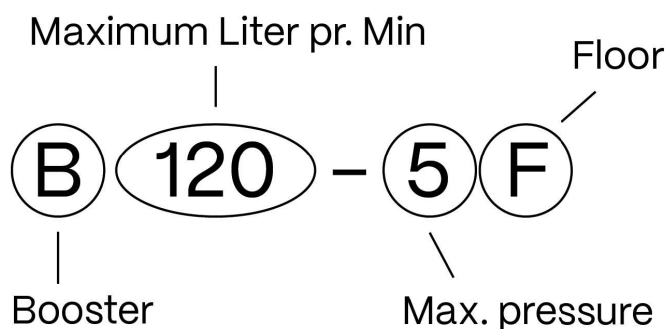

Model	Users	Pressure	Flow rate	Item number	Page
B 120-5F	-	5 bar	120 l/min	7012060	60
B 270-3F	-	3 bar	270 l/min	7012061	61
B 630-3F	-	3 bar	630 l/min	7012062	62
B 810-3F	-	3 bar	810 l/min	7012063	63
B 1080-3F	-	3 bar	1080 l/min	7012064	64



B 120-5F



Included accessories
→ AirVent

Supplies: B050-27F, B065-27F, B100-27F, B120-27F

Optional accessories
→ Installation kits

Technical Specifications	Unit	B 120-5F
Pump pressure	Bar	5
Max. water consumption	L/Min	120
Pipe dimesions inlet/outlet	Inch	1 ½"
Standard Voltage	V	380-480
Frequency & Power	Hz/kW	50-60/3,0
Dimensions (WxHxD)	mm	608x777x400
Weight	Kg	52
Item Number	No.	7012060

B 270-3F



Included accessories
→ AirVent

Supplies: B050-27F, B065-27F, B100-27F,
B120-27F, B200-27F, B270-27F

Optional accessories
→ Installation kits

Technical Specifications	Unit	B 270-3F
Pump pressure	Bar	3
Max. water consumption	L/Min	270
Pipe dimensions inlet/outlet	Inch	2"
Standard Voltage	V	380-500
Frequency & Power	Hz/kW	50-60/3,0
Dimensions (WxHxD)	mm	695x850x400
Weight	Kg	50
Item Number	No.	7012061



B 630-3F



Supplies: B400-27F, B570-27F, B630-27F

Included accessories
→ AirVent

Optional accessories
→ Installation kits

Technical Specifications	Unit	B 630-3F
Pump pressure	Bar	3
Max. water consumption	L/Min	630
Pipe dimesions inlet/outlet	Inch/DN	3"/80
Standard Voltage	V	380-480
Frequency & Power	Hz/kW	50-60/5,5
Dimensions (WxHxD)	mm	573x1031x400
Weight	Kg	112
Item Number	No.	7012062

B 810-3F

Included accessories
→ AirVent

Optional accessories
→ Installation kits



Supplies: B810-27F

Technical Specifications	Unit	B 810-3F
Pump pressure	Bar	3
Max. water consumption	L/Min	810
Pipe dimensions inlet/outlet	Inch/DN	3"/ 80
Standard Voltage	V	380-500
Frequency & Power	Hz/kW	50-60/7,5
Dimensions (WxHxD)	mm	650x1040x400
Weight	Kg	160
Item Number	No.	7012063



B 1080-3F



Supplies: B1080-27F

Included accessories
→ AirVent

Optional accessories
→ Installation kits

Technical Specifications	Unit	B 1080-3F
Pump pressure	Bar	3
Max. water consumption	L/Min	1080
Pipe dimesions inlet/outlet	Inch/DN	4"/ 100
Standard Voltage	V	380-480
Frequency & Power	Hz/kW	50-60/11,0
Dimensions (WxHxD)	mm	630x1180x400
Weight	Kg	180
Item Number	No.	7012064





Pre-diluted systems

The Foamico Pre-Diluted System is the ideal solution when concentrated chemicals are not desired on the production floor. The system includes a centrally located mixing station, booster, and satellites – typically installed in a plant or utility room – with additional satellites on the production floor.

The following section outlines and explains the technical specifications of the Pre-Diluted mixing station and satellites. The booster used in the Pre-Diluted System is described in detail in the previous booster section.



Model	Users	Pressure	Flow rate	Item number	Page
Prediluted satellites	1-2	27 bar	50 l/min	-	67-71
Mixing stations	1-25	27 bar	40-240 l/min	-	72-74

Pre-diluted Satellites

Foamico's Pre-Diluted Satellites come in three standard models, offering over 16 different configuration options. While the system is centrally located away from the production floor, it is also possible to connect one local chemical if a specific cleaning process requires a higher concentration. The pre-diluted satellite can handle up to three pre-diluted chemicals. Additionally, an extra outlet can be added to the satellite, allowing two operators to clean at the same time for improved efficiency.

Explanation of Model Name

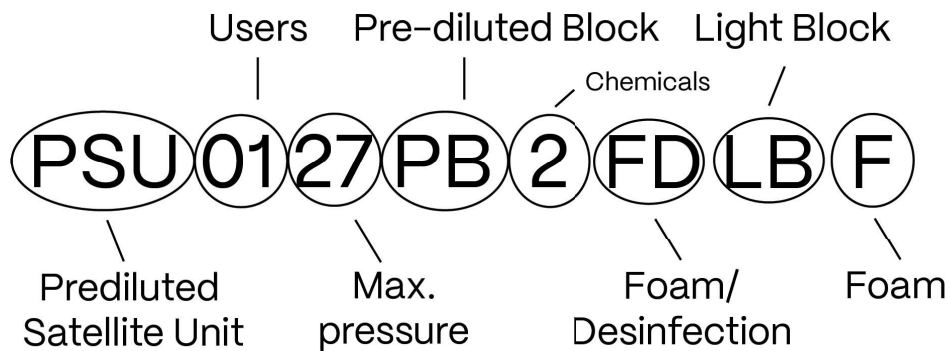

Model	Users	Pressure	Flow rate	Item number	Page
PSU 0127 (PB2)	1	27 bar	50 l/min	70331319	69
PSU 0127 (PB2 + LB)	2	27 bar	50 l/min	7013321	70
PSU 0127 (PB3)	1	27 bar	50 l/min	7013315	71



Included

All our Pre-diluted satellites are equipped with a variety of integrated features designed to enhance efficiency and ease of use.



Smart Switch

Single-handle operation streamlines control of all functionalities.

Optional

All our Prediluted satellites offer a variety of optional accessories designed to further enhance functionality and customization based on your needs.

FlowGuard

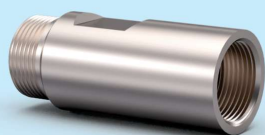

Our FlowGuard is a patented technology designed to enhance performance and reduced water usage.

Item Number: 1002509

Installationkits

Model	Item number
Water	7800395 ½"
Air	7800449 ½"

Additional accessories



To enhance the functionality and customization of our products, we offer a range of additional accessories. You can find the full selection at the back of the catalog.

PSU 0127

Two prediluted chemicals

Included accessories

- 25/30 Rinsing Nozzle – "High Impact"
- 25/30 Rinsing Lance – "High Impact"
- 50/200 Foam Nozzle
- 40/30 Disinfection Nozzle
- Nozzle holder

→ Optional accessories

- Foamico hose
- Low pressure valve/low pressure gun
- Hose holder or hose reels
- Trolley



Technical specifications	Unit	PSU 0127-PB2-FD/FF
Dimensions (WxHxD)	mm	450x260x200
Weight	Kg	11
Item number	No.	70331319
Water		
Min./Max inlet pressure	Bar/PSI	12-25/174-363
Max. water consumption	L/Min	50
Pipe dimension inlet/outlet	Inch	1/2"
Prediluted Chemicals		
Min./Max. inlet pressure	Bar/PSI	5-8/73-116
Max. Pre-Diluted chemicals	L/Min	10
Pipe dimension inlet/outlet	Inch	1/2"



PSU 0127

Two prediluted chemicals One local chemical

Included accessories

- 25/30 Rinsing Nozzle - "High Impact"
- 25/30 Rinsing Lance - "High Impact"
- 50/200 Foam Nozzle
- 40/30 Disinfection Nozzle
- Nozzle holder

Optional accessories

- Foamico hose
- Low pressure valve/low pressure gun
- Hose holder or hose reels
- Trolley



Technical specifications	Unit	PSU 0127-PB2-FD_LB-F
Dimensions (WxHxD)	mm	450x260x200
Weight	Kg	13
Item number	No.	7013321
Water		
Min./Max inlet pressure	Bar/PSI	12-25/174-363
Max. water consumption	L/Min	50
Pipe dimension inlet/outlet	Inch	1/2"
Prediluted Chemicals		
Min./Max. inlet pressure	Bar/PSI	5-8/73-116
Max. Pre-Diluted chemicals	L/Min	10
Pipe dimension inlet/outlet	Inch	1/2"

PSU 0127

Three prediluted chemicals

Included accessories

- 25/30 Rinsing Nozzle – "High Impact"
- 25/30 Rinsing Lance – "High Impact"
- 50/200 Foam Nozzle
- 40/30 Disinfection Nozzle
- Nozzle holder

→ Optional accessories

- Foamico hose
- Low pressure valve/low pressure gun
- Hose holder or hose reels
- Trolley

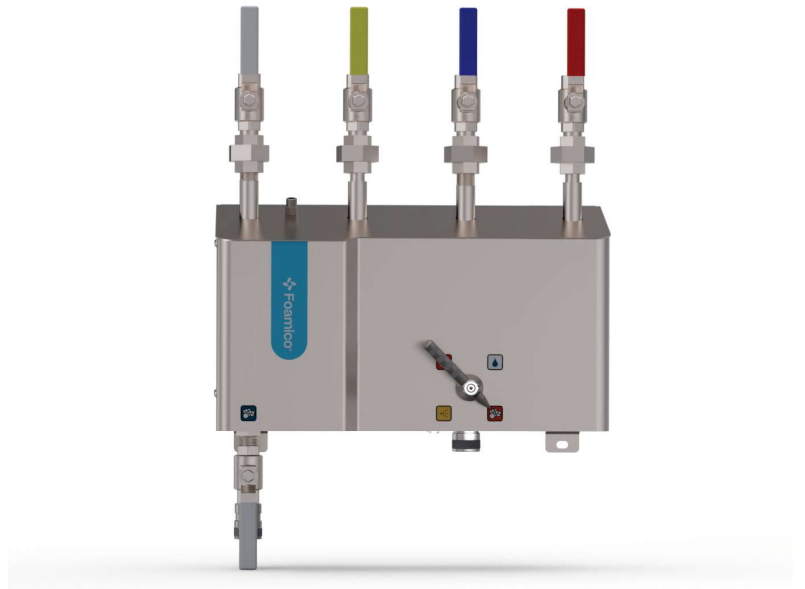

Technical specifications	Unit	PSU 0127-PB2-FD_SP-F
Dimensions (WxHxD)	mm	440x260x200
Weight	Kg	13
Item number	No.	7013315
Water		
Min./Max inlet pressure	Bar/PSI	12-25/174-363
Max. water consumption	L/Min	50
Pipe dimension inlet/outlet	Inch	½"
Prediluted Chemicals		
Min./Max. inlet pressure	Bar/PSI	6-8
Max. Pre-Diluted chemicals	L/Min	10
Pipe dimension inlet/outlet	Inch	½"



Mixing stations

The Foamico Mixing Station is the heart of a centralized cleaning solution where water and chemicals are mixed before being distributed to the satellites. By using a venturi-based system, our solution mixes chemicals with maximum accuracy and consistency – without the need for dosing pumps or complex mechanics.

This simple, robust design reduces maintenance, ensures reliable operation, and guarantees that every satellite receives the right concentration for effective and safe cleaning. Easy to integrate, energyefficient, and built for long lasting performance.

Explanation of Model Name

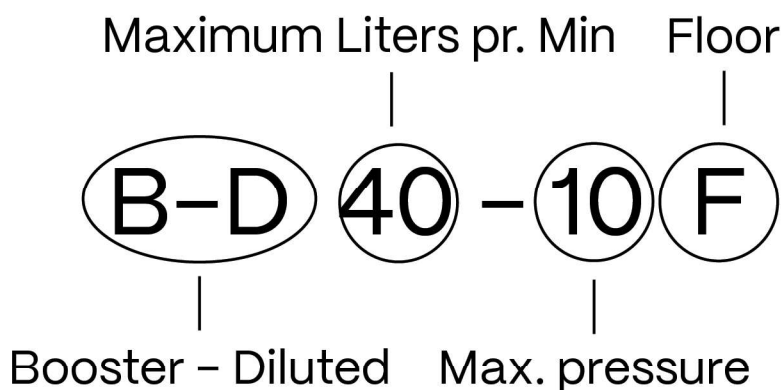

Model	Users	Pressure	Flow rate	Item number	Page
B-D 40-10F	1-5	10 bar	40 L/Min	7012050/54	74
B-D 80-10F	1-10	10 bar	80 L/Min	7012051/55	74
B-D 120-10F	1-15	10 bar	120 L/Min	7012052/56	74
B-D 240-10F	1-25	10 bar	240 L/Min	7012057/58	74

Included

All our Pre-diluted satellites are equipped with a variety of integrated features designed to enhance efficiency and ease of use.



Frequency controlled

with newest Grundfos technology

E15

High performance with E15 standard motor



Digital display

Easily readable and integrated into the pump, enhancing user interaction by allowing precise monitoring and control of the pump's settings and performance. Password-protected.

Filter, hose and pressure valve

Each unit is ready to use, delivered with a 10-meter suction hose with filter for direct connection to chemical drums or IBCs, and an inlet pressure regulation valve to ensure stable water supply and accurate dosing.

Installation kits

Size	Item number
1 1/4"	7800399
2"	7800401
Air	7800449



B-D 40/80/ 120/240 – 10F



Technical specifications	Unit	40-10F	80-10F	120-10F	240-10F
Pump pressure	Bar	10	10	10	10
Min./Max inlet pressure	Bar	2/10	2/10	2/10	2/10
Max. water consumption	L/Min	40	80	120	240
Max. water temperature	°C	40	40	40	40
Pipe dimension inlet/outlet	Inch	1 ¼"	1 ¼"	1 ¼"	2"
Users	Amount	1-5	1-10	1-15	1-25
Standard Voltage	V	380-480	380-480	380-480	380-480
Frequency & Power	Hz/kW	50-60/ 3,0	50-60/ 3,0	50-60/ 3,0	50-60/ 6,0
Dimensions (WxDxH)	mm	1200x1260x710	(=)	(=)	(=)
Weight	Kg	155	155	155	165
Item number (EPDM)	No.	7012050	7012051	7012052	7012057
Item number (VITON)	No.	7012054	7012055	7012056	7012058





Retail/Institutional Cleaning Equipment

Foamico represents the very best in engineering surface cleaning solutions, offering advanced Retail/Institutional cleaning equipment specifically designed for high-demand environments such as hotels, retail spaces, restaurants, large kitchens, bakeries, and butcheries.

Our systems deliver exceptional results effortlessly – easy to install, simple to operate, and built to meet the highest standards of cleanliness in any setting. The systems are available both as main stations, delivering up to 6 bar pressure, and as satellites that can be connected directly to the water supply.

Everything is included in our Retail/institutional products.

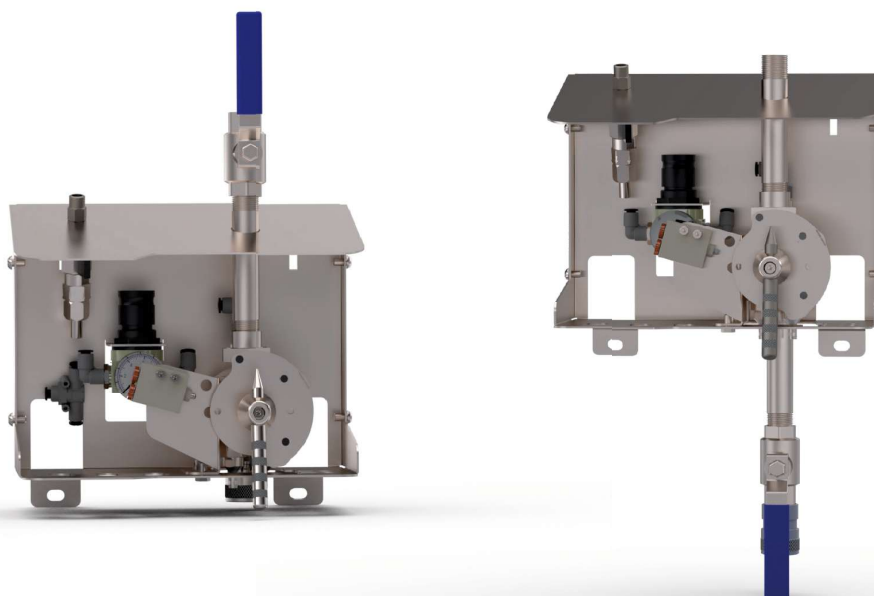

Model	Users	Pressure	Flow rate	Item number	Page
MS & MSC 0106	1	6 bar	30 l/min	See page 78	77-78
SU 0110 TWP Light	1	2-10 bar	50 l/min	7011020	79
SU 0110 TWP Light XA	1	2-10 bar	50 l/min	7011023	80
SU 0110 TWP Baseline	1	2-10 bar	50 l/min	7011338	81
SU 0110 TWP Baseline XA	1	2-10 bar	50 l/min	7011339	82
Trolley	-	-	-	7002085	22

MS & MSC 0106

Foamico's MS / MSC 0106 is a stand-alone cleaning system delivering up to 6 bar pressure. Available with or without a compressor, it handles two chemicals (foam/disinfectant) and comes complete with hose, gun/valve, and nozzles. Simply mount it on the wall or place it on a trolley – and you're ready to clean.





Note: One of the four kits displayed on page 78 must be chosen at the time of purchase.



Technical specifications	Unit	MSC 0106 * With compressor	MS 0106 XA * Without compressor
Pump pressure (2 bar inlet)	Bar/PSI	6/87	6/87
Max. water consumption	L/Min	30	30
Max temperature	°C	70	70
Pipe dimension inlet/outlet	Inch	1"	1"
Standard Voltage	V	1x220–240	1x220–240
Frequency & Power	Hz/kW	50/1,3	50/0,5
Dimensions (WxHxD)	mm	514x505x325	514x505x325
Weight	Kg	43	34



Included for MS & MSC 0106

			
Item number: 7001423/25	Item number: 7001429/31	Item number: 7001421	Item number: 7001427
Kit 1	Kit 2	Kit 3	Kit 4

Optional for MS & MSC 0106

Trolley

Item number: 7002085



SU 0110 TWP Light

The SU 0110 TWP Light satellite requires tap water and external air for operation.

- Included accessories
- Chemical Limiting Nozzle set
- 25/30 Rinsing Nozzle – "High Impact"
- 50/200 Foam Nozzle
- 12,5 meter ¾" hose
- Brass ball valve
- Nozzle holder

- Optional accessories
- Low pressure valve SS
- Hose holder
- Trolley



Technical specifications	Unit	SU 0110 TWP Light
Min./Max. Inlet pressure	Bar/PSI	2-10/29-145
Max. water consumption	L/Min	50
Pipe dimesions inlet (Water)	Inch	½"
Pipe dimesions inlet (Air)	mm	8
Air supply	Bar/PSI	5-10/73-145
Air consumption	L/Min	150-200
Dimensions (WxHxD)	mm	214x118x86
Weight	Kg	3,5
Item number	No.	7011020



SU 0110 TWP Light XA

The SU 0110 TWP Light XA satellite requires tap water.

- Included accessories
- Chemical Limiting Nozzle set
- PVC Hose and nozzle Holder
- 15/30 Rinsing Nozzle
- Turbo Foam Nozzle
- 10 meter ½" hose
- Foam Gun

- Optional accessories
- Low pressure valve SS
- Trolley



Technical specifications	Unit	SU 0110 TWP Light XA
Min./Max. Inlet pressure	Bar/PSI	2-10/29-145
Max. water consumption	L/Min	50
Pipe dimesions inlet (Water)	Inch	½"
Dimensions (WxHxD)	mm	214x118x86
Weight	Kg	3,5
Item number	No.	7011023

SU 0110

TWP Baseline

The SU 0110 TWP Baseline satellite requires tap water and external air for operation.

- Included accessories
- 2xChemical Limiting Nozzle set
- 25/30 Rinsing Nozzle – "High Impact"
- 50/200 Foam Nozzle
- 12,5 meter ¾" hose
- Brass ball valve
- Nozzle holder

- Optional accessories*
- Low pressure valve SS
- Hose holder
- Trolley



Technical specifications	Unit	SU 0110 TWP Light
Min./Max. Inlet pressure	Bar/PSI	2-10/29-145
Max. water consumption	L/Min	50
Pipe dimesions inlet (Water)	Inch	½"
Pipe dimesions inlet (Air)	mm	8
Air supply	Bar/PSI	5-10/73-145
Air consumption	L/Min	150-200
Dimensions (WxHxD)	mm	214x118x86
Weight	Kg	3,5
Item number	No.	7011338



SU 0110 TWP Baseline XA

The SU 0110 TWP Baseline XA satellite requires tap water for operation.

- Included accessories
- 2xChemical Limiting Nozzle set
- PVC Hose and nozzle Holder
- 15/30 Rinsing Nozzle
- Turbo Foam Nozzle
- 10 meter ½" hose
- Foam Gun

- Optional accessories*
- Low pressure valve SS
- Trolley



Technical specifications	Unit	SU 0110 TWP Baseline XA
Min./Max. Inlet pressure	Bar/PSI	2-10/29-145
Max. water consumption	L/Min	50
Pipe dimensions inlet (Water)	Inch	½"
Dimensions (WxHxD)	mm	260x360x200
Weight	Kg	6
Item number	No.	7011339



Accessories

To achieve the best cleaning results, every detail matters. That's why Foamico offers a comprehensive range of high-quality accessories designed to enhance performance, durability, and ease of use. From hoses and nozzles to fittings and installation kits, our accessories ensure you have everything you need for a seamless and efficient cleaning process.

No matter the task, our carefully selected accessories are built to support professional cleaning in demanding environments, ensuring reliability and precision at every step.



Foamico DuraLine hose

Item number	Description
7800544	1,5 m Foamico DuraLine Hose
7800545	2,5 m Foamico DuraLine Hose
7800546	5 m Foamico DuraLine Hose
7800547	10 m Foamico DuraLine Hose
7800548	15 m Foamico DuraLine Hose
7800549	20 m Foamico DuraLine Hose
7800550	25 m Foamico DuraLineHose
7800551	30 m Foamico DuraLine Hose
7800552	35 m Foamico DuraLineHose
7800553	40 m Foamico DuraLine Hose
7800554	100 m Foamico DuraLine Hose

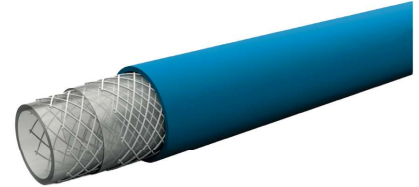

Foamico DuraLine Hose – durable and dependable. Engineered for flexibility, ensuring easy handling in everyday use. Provides a consistent water flow for efficient cleaning performance. Proven to perform under demanding conditions with excellent results.

Standard hose

Item number	Description
7800171	2,5 m Standard Hose
7800172	10 m Standard Hose
7800173	15 m Standard Hose
7800174	20 m Standard Hose
7800175	25 m Standard Hose
7800176	30 m Standard Hose
7800281	40 m Standard Hose
7800234	120 m Standard Hose (Without press couplings)



Foamico standard hoses feature stainless steel press couplings with a 1/2" outer thread. They operate in temperatures ranging from -20 to +70 degrees Celsius and can handle a maximum pressure of 80 bar at 20 degrees.

Hose fittings stainless steel



Item number: 1700454
Description: Insert for hose
Stainless steel Outer Thread 1/2



Item number: 1700488
Description: Insert for hose
Stainless steel Outer Thread 1/2



Item number: 1700453
Description: Outer cape for hose
Stainless steel Outer Thread 1/2

Hose fittings galvanized steel



Item number: 1700208
Description: Insert for hose
Stainless steel Outer Thread 1/2



Item number: 1700209
Description: Insert for hose
Stainless steel Inner Thread 1/2



Item number: 1700210
Description: Outer cape for hose
1/2"

Can holders Fits 1,2 or 3-23 liter cans



Item number: 1700295
Description: Single Can holder
1x 270mm x323mm



Item number: 1700298
Description: Double Can holder
2x 270mmx323mm



Item number: 1001016
Description: Triple Can holder
3x 270mmx323mm



Low pressure guns

7800161 Foam Gun ST-2725 with ST-3100 vulcanized rubber coupling and with Swivel



7800384 Foam Gun ST-2725 with hard plastic protector on coupling and with Swivel



7800392 Foam Gun 12-80 with coupling and with Swivel. Up to 60 bar pressure



1700316 Foam Gun ST-510 for TWP XA satellite and with coupling



Low pressure valves

7800058 Low pressure valve SS with vulcanised coupling



7800203 Rubber low pressure valve with vulcanised coupling



Chemical limiting nozzles

Chemical limiting nozzles in high-resistant plastic, set includes sizes: 0.0mm, 0.3mm, 0.5mm, 0.6mm, 0.7mm, 0.8mm, 0.9mm, 1.1mm, 1.3mm, and 1.5mm. The variety of nozzles ensures precise chemical concentration.

7800291 Chemical limiting nozzles 0,0mm - 1,5mm



7800347 Chemical limiting nozzles 1,1mm - 2,8mm



Inlet hoses for mobile units

7800112	3/4" 10m hose
7800291	1" 10m hose



Various chemical hoses

1700022	Chemical hose, blue
1700023	Chemical hose, yellow
1700108	Chemical hose, red
1700156	Chemical hose, clear
1000256	Chemical hose filter

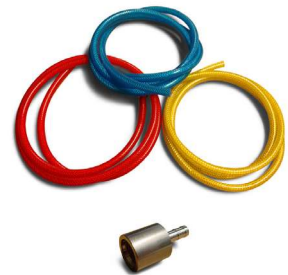

Hose reel- and holders

7800111	Hose Reel Nedermann 886 (automatic) Max. 25 meter 1/2" hose
1000510	Pivot wall bracket for Nedermann 886



7800430	25m Hose reel Automatic, Stainless steel
7800431	30m Hose reel Automatic, Stainless steel
7800432	Swiveling bracket for 25m hose reel
7800433	Swiveling bracket for 25m hose reel



1002839	Hose holder SS for wall mount
---------	-------------------------------





Rinsing nozzles

We offer stainless steel rinsing nozzles. If your nozzle isn't listed, contact us. First two digits show spray angle, last two show water consumption per minute.

7800147	Rinsing Nozzle 15/25 High Impact
7800000	Rinsing Nozzle 15/30 High Impact
7800001	Rinsing Nozzle 15/40 High Impact
7800126	Rinsing Nozzle 25/25 High Impact
7800002	Rinsing Nozzle 25/30 High Impact
7800003	Rinsing Nozzle 25/40 High Impact
7800182	Rinsing Nozzle 25/50 High Impact



Foam nozzles

We offer foam nozzles in stainless steel. Below is our standard selection. First two digits show spray angle, last three indicate foam volume per minute.

7800008	Foam Nozzle 65/150
7800009	Foam Nozzle 50/200



Couplings and ball valves

Item number: 1000028
Description: Male coupling
1/4" with inner thread, SS



Item number: 1000029
Description: Male coupling 1
1/2" with inner thread, SS



Item number: 1000037
Description: Quick Connect
Coupling 1/2" outside thread,
SS



Item number: 1000038
Description: Quick Connect
Coupling 1/2" outside thread
with vulcanized coupling, SS



Item number: 7800135
Description: Press coupling
1/2" outer thread, SS



Item number: 1001200
Description: Quick Connect
Coupling 3/8" outside thread
with vulcanized coupling, SS



Item number: 7800076
Description: Ball valve til
T-Piece 1/2" inner thread, SS
Incl. 1000037 Quick Coupling
1/2"



Item number: 7800353
Description: Ball valve til
L-grip 1/2" inner thread, SS
Incl. 1000037 Quick Coupling
1/2"



Item number: 1000266
Description: Ball valve with
T-piece 1/2" inner thread, SS



Item number: 1000069
Description: Ball valve with L-grip 1/2"
inner thread, SS





Rinsing lances

We offer stainless steel rinsing lances. Below is our standard selection. Contact us if your nozzle isn't listed. First two digits show spray angle, the last shows water consumption per minute.

7800151	Rinsing Lance 15/25 High Impact
7800078	Rinsing Lance 15/30 High Impact
7800079	Rinsing Lance 15/40 High Impact
7800152	Rinsing Lance 25/25 High Impact
7800080	Rinsing Lance 25/30 High Impact
7800081	Rinsing Lance 25/40 High Impact
7800183	Rinsing Lance 25/50 High Impact



Foam lances

We offer foam lances with stainless steel nozzles. Below is our standard selection. First two digits show spray angle, the last shows water consumption per minute.

78000114	Foam Nozzle 65/150
78000139	Foam Nozzle 50/200



Installation kits

Foamico Installation Kits prevent damage from fragments and metal parts in piping, which can harm the flowswitch or pump chambers. We offer kits for Main Station, Satellite, and Booster installations. They should be mounted before the water inlet and are available in 1/2" (Satellite Kit), 1", 1 1/4", 1 1/2", and 2". Kits include ball valves, pipe filters, unions, and nipples. We highly recommend them for all installations to protect flow-switches, chamber stacks, and injectors.

7800395	Installation Kit for Satellite Contains: 1pcs 1/2" Ballvalve, 1 pcs 1/2" Pipe Strainer and 1pcs 1/2" Union Strait
7800398	Installation Kit 1" Contains: 2 pcs 1" Ballvalve, 1 pcs 1" Pipe Strainer, 2pcs 1" Union Strait and 1 pcs 1" Hexagon Nipple
7800399	Installation Kit 1 1/4" Contains: 2 pcs 1 1/4" Ballvalve, 1 pcs 1 1/4" Pipe Strainer, 2 pcs 1 1/4" Union Strait and 1 pcs 1 1/4" Hexagon Nipple
7800400	Installation Kit 1 1/2" Contains: 2 pcs 1 1/2" Ballvalve, 1 pcs 1 1/2" Pipe Strainer, 2 pcs 1 1/2" Union Strait and 1 pcs 1 1/2" Hexagon Nipple
7800401	Installation Kit 2" Contains: 2 pcs 2" Ballvalve, 1 pcs 2" Pipe Strainer, 2 pcs 2" Union Strait and 1 pcs 2" Hexagon Nipple
7800449	Installation Kit for Air Contains: 1 pcs 1/2" Ballvalve, 1 pcs 1/2" - 3/8" Bushing, 1 pcs 90° for 8mm Air Hose, 1 pcs Air Hose 8mm



*7800395



*7800398/99/00/01/02



Turbo foam nozzle

The Turbo Foam Nozzle is designed for our tap water units and MS ULTRA NEXT 0106 program, delivering excellent foam without the need for compressed air.

1001668	Turbo Foam Nozzle
---------	-------------------



Disinfection nozzle

Our disinfection nozzles are only available in stainless steel. First two digits show spray angle, the last shows water consumption per minute.

7800012	Disinfection Nozzle 40/30
---------	---------------------------

7800013	Disinfection Nozzle 50/30
---------	---------------------------



Nozzle protectors

7800042	Nozzle protector White
---------	------------------------

78000323	Nozzle protector Grey
----------	-----------------------

78000322	Nozzle protector Red
----------	----------------------

780040	Nozzle protector Green
--------	------------------------

780041	Nozzle protector Yellow
--------	-------------------------

780039	Nozzle protector Light Blue
--------	-----------------------------

78000321	Nozzle protector Dark Blue
----------	----------------------------



Nozzle holder

1001120	Nozzle Holder 5pcs.
---------	---------------------

